

THE MOST COMPLETE, VERSATILE AND DESIGNER FRIENDLY TRANSLUCENT SYSTEM AVAILABLE TODAY



The CPI Danpalon® Nano-Cell® patented, standing seam dry-glazed system, is available in a variety of daylighting configurations suitable for different requirements and applications as illustrated below:

Quadwall® System

2.75" (70mm) U = 0.23*
(w. bat insul. U = 0.08 - 0.18)*

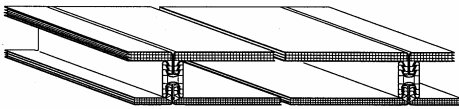

The preferred system for daylighting over enclosed climate controlled spaces, Quadwall® is an assembly of two Nano-Cell® panels containing a total of seven isolated air spaces. The two-layer design empowers the architect with increased control over light, solar transmittance, colors and insulation levels. Quadwall® provides superior performance for the cost over any competitive material. The patented standing seam connector allows the efficient addition of a second layer at marginal extra cost.

Double layer of protection. The two layers of glazing provide redundant protection of the covered space. The Quadwall system's longevity can be extended indefinitely by replacing exterior glazing panels without exposing the building's interior. In comparison, adding or replacing a double layer on other glazing systems would require significant extra cost, and any damage to the exterior face would require intensive repairs that would interrupt the building's function.

Quadwall® Longspan System

4" (102mm) U = 0.22 - 0.23*
(w. bat insul. U = 0.08 - 0.18)*

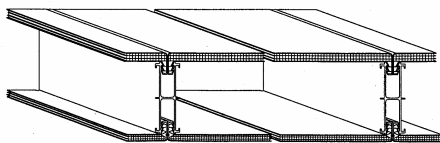

All of the advantages of the Quadwall® system with the addition of aluminum H connectors, allowing the greatest spanning capability. Available in Class "A", Class "B" and Class "C" fire rated roof assembly listings.

Pentaglas® 12 System

0.47" (12mm) U = 0.48*

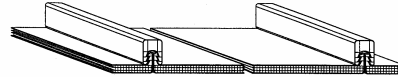

Homogeneous insulating single panel with *three layers of isolated air spaces* and Nano-Cell® spacing due to smaller spans between rib supports (0.16"x0.16"). This panel style uses Nano-Cell® technology for superb performance. Insulating values are comparable to 1" insulated glass but at a reduced cost and weight.

Pentaglas® 16 System

0.63" (16mm) U = 0.38*

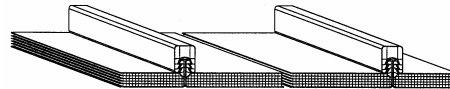

Homogeneous insulating panel with *five layers of isolated air spaces* and Nano-Cell® spacing due to smaller spans between rib supports (0.16"x0.16"). Extraordinary insulation value comparable to bulky insulated fiberglass panels. Offers improved spanning capabilities and unequalled architectural appeal.

Pentaglas® 12mm, 16mm Longspan

0.47" (12mm) U = 0.48*

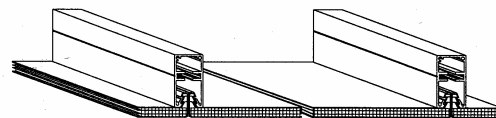

All of the advantages of the Pentaglas® system with the addition of aluminum battens, allowing increase spanning capability. Choice of batten accent finishes available to enable a variety of designs.

Protected by US Patent #'s: 6,164,024 - 5,437,129 - 4,573,300 - 5,348,790 - 5,387,456 - 5,895,709 - 6,499,255 and patents pending
*U factor - center of glass

INTRODUCTION TO CPI TRANSLUCENT PANEL SYSTEMS

CPI Translucent Daylighting systems, including Pentaglas® and Quadwall®, incorporate the Danpalon® Nano-Cell® patented standing-seam polycarbonate panels.



The Heart of the System – the Nano-Cell® Difference

What makes the CPI panels' performance unique and effective is the heart of the system. The Nano-Cell® system by CPI consists of:

- A. Main polycarbonate panels 2' nominal widths, extruded with Nano-Cell® technology and with standing seam, 5/8" (115mm) upstands protruding 90° to the panel face
- B. Grip-lock double tooth design of snap-on and interlocking dry-glazed profiles
- C. Concealed patented HD stainless steel and aluminum retention clips utilizing continuous top flanges.
- D. Structural supporting systems
- E. Variety of perimeter aluminum engagement profiles

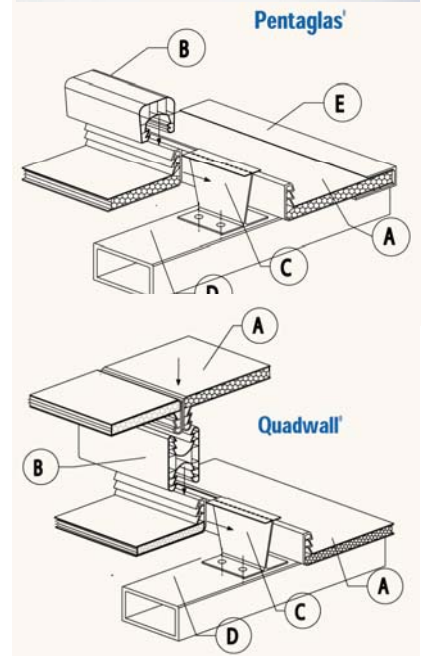
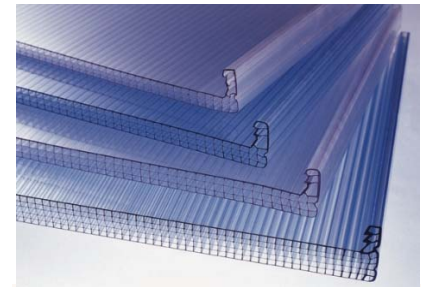

The fully assembled system is free-floating. Every component is free to thermally expand or contract at its own rate along the X, Y & Z axis, eliminating oil canning and delamination difficulties and allowing the material to retain structural properties over the life of the skylight. Structural movement is absorbed within the flexible nature of the system, making skinning directly to steel or wood structures possible.

The entire assembly uses no caulking or adhesives for its performance, eliminating the difficulty of sealant and adhesive bond failure common in traditional systems. The Danpalon® system connection and weather seal is mechanical, dry, and 100% effective.

The System May be Panelized

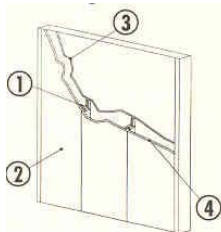

Quadwall® Panelized Unit

- 1. Standing seam dry-glazed joint - eliminates need for adhesive bond
- 2. Co-extruded super weathering architectural face – eliminates need for periodic resurfacing
- 3. Prismatic Nano-Cell® truss-like “Smart” design – eliminates need for batt insulation
- 4. 0.4” self-supporting face – eliminates need for internal aluminum grid supports

Protected by US Patent #'s: 6,164,024 – 5,437,129 - 4,573,300 – 5,348,790 – 5,387,455 -- 5,875,709 – 6,499,255